



www.dynam-rc.cn

迪乐美

Before commencing assembly, Please read the instruction manual!



**RAPID**

## Instruction Manual

► **Specification:** Item: DY8965

Wingspan: — — — — — .635 mm(25in)

Overall Length: — — — — — 627.5 mm(24.7in)

Wing Loading: — — — — — 40.7g/dm<sup>2</sup>

Servo: — — — — — 3.7g x4pcs

Battery: — — — — — 11.1V 800mAh Li-Po, 25C

Speed Controller: — — — — — 18A Brushless

Motor Size: — — — — — BM2313 KV1500 Brushless Outrunner

Flying Weight: — — — — — 330g(11.7oz)



### SAFETY PRECAUTIONS

**This radio control model is not a toy!**

- First-time builders should seek advice from people having building experience in order to assemble the model correctly and to produce its performance to full extent.
- Assemble this kit only in places out of children's reach!
- Take enough safety precautions prior to operating this model. You are responsible for this model's assembly and safe operation!
- Always keep this instruction manual ready at hand for quick reference, even after completing the assembly.

Shen Zhen Dynam Industry & Trade Co.,LTD

CE 0678 ! FC  

TEL:+86-769-87566018 FAX:+86-769-87555185 E-mail:sales@dynam-rc.cn

Made In China

# Safety Precautions

- ◆ Never fly the Airplane where there are crowds of people, power lines overhead, automobiles or near highways. Give yourself plenty of room for flying, as the plane can travel at a high rate of speed. Remember you are responsible for the safety of others.
- ◆ Do not fly in strong winds.
- ◆ Do not attempt to catch the Airplane while flying.
- ◆ Children under the age of 16 should not have admission to the transmitter for the plane.
- ◆ Never leave this system unattended, with the batteries in the unit and around children. Injury can result by children turning on the transmitter or the plane.
- ◆ Keep away from the propeller at all times. The system can automatically start when the batteries are plugged in, regardless if the transmitter is in the on or off position. The propeller can cause injury!
- ◆ Before flying, always remember to turn on the transmitter first, before plugging in the battery pack. Stay clear of propeller.
- ◆ Always turn the speed controller all the way down and the switch on "OFF". (left control stick in the down position) before starting; otherwise the propeller will start on full power when you plug the battery into the plane.
- ◆ After running the motor, disconnect the battery first before turning off the transmitter, otherwise the propeller may start at full power.
- ◆ Never leave the charger or battery near wet areas.
- ◆ Completely discharging a Li-poly battery can result in permanent damage to the cells of the battery. Therefore you must always remember to disconnect the battery after using the plane.

## Before You Begin

- ◆ Read through the manual before you begin, so you will have an overall idea of what to do.
- ◆ Check all parts. If you find any defective or missing parts contact your local dealer. Please DRY FIT and check for defects for all parts that will require CA or Epoxy for final assembly. Any parts you find to be defective after the gluing process may be difficult to remove for warranty replacement. The manufacturer will replace any defective parts, but will be difficult to extend to the good parts that are good before gluing to defective parts during assembly.
- ◆ Symbols used throughout this instruction manual comprise of following:



Apply epoxy glue



Assemble left and right sides the same way.



Pay close attention here!



pliers



Ensure smooth non-binding movement while assembling.



Cut off shaded portion



# How to use your dynam 2.4G rc system

## ● important

1. Put down throttle sticker.
2. Turn on transmitter power-switch.
3. Please let your receiver connect with battery in 10 seconds.
4. Check your protect-switch,  
when protect-switch in up station,put down,release from protect.  
when protect-switch in down station,put up frist,then put down again,  
release from protect,you can fly now .



## RTF Including

---



### RTF including:

---

- Fuselage
- Wing
- Elevator
- Landing gear
- Spinner
- Propeller
- Li-Po battery (11.1V 800mAh 25C)
- Transmitter
- Balance charger
- Adaptor
- Decal

# Assembly



**1** Fix the wing with PM3\*25mm screw.



**2** Install the landing gear with PM3\*25mm screws.

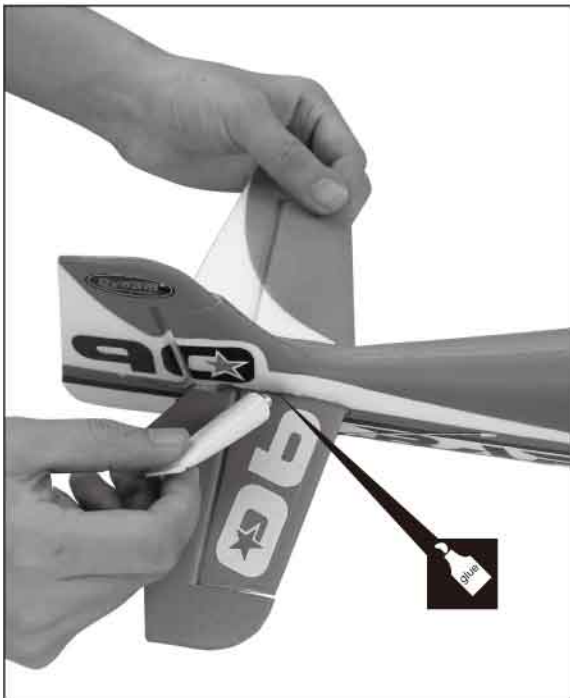

**3** Apply some glue on the area of contact for the stabilizer. Glue the stabilizer in place.

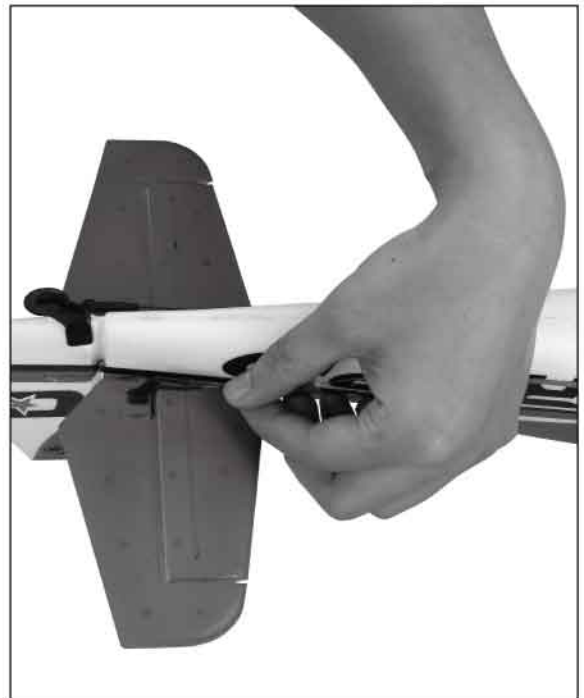

**4** Install elevator push rod as shown.

# Assembly



**5** Install rudder push rod as shown.

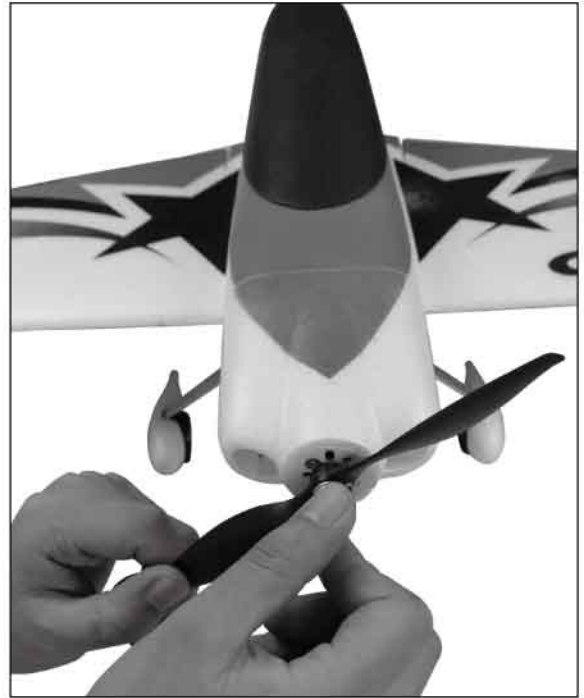

**6** Install the propeller.



**7** Glue the spinner.



**8** It shows how to open the canopy.

# Stick Operation

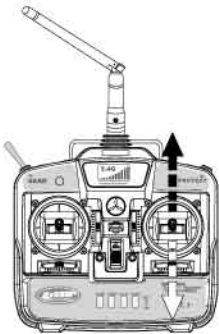
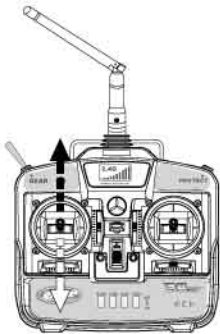
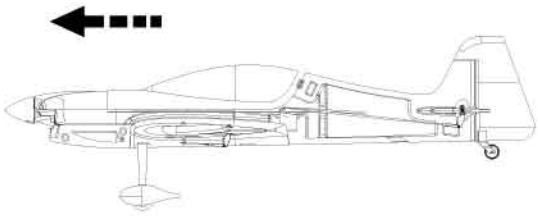
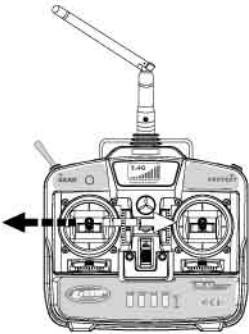
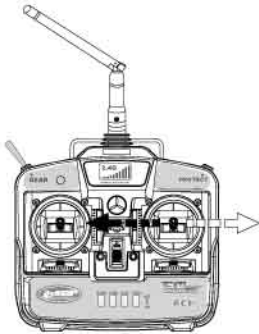
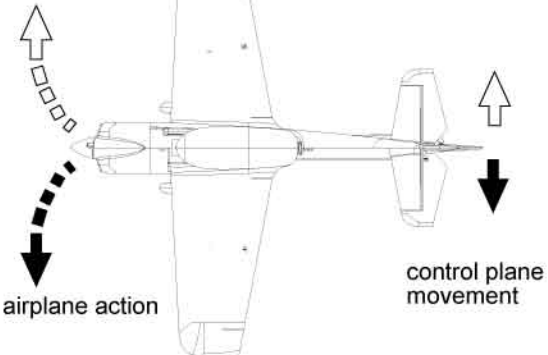
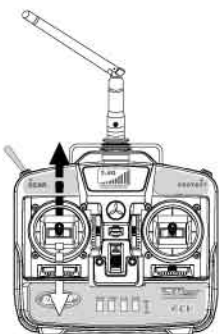
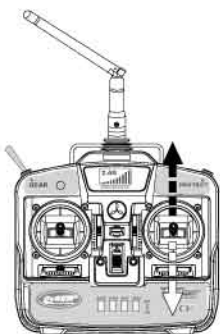
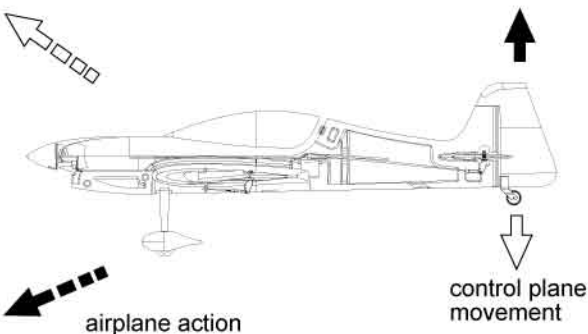
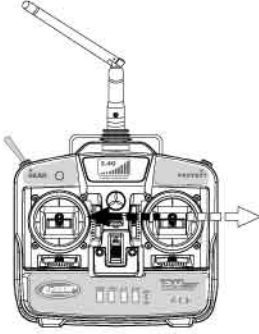
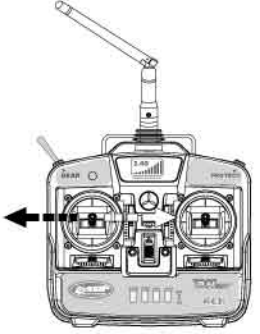
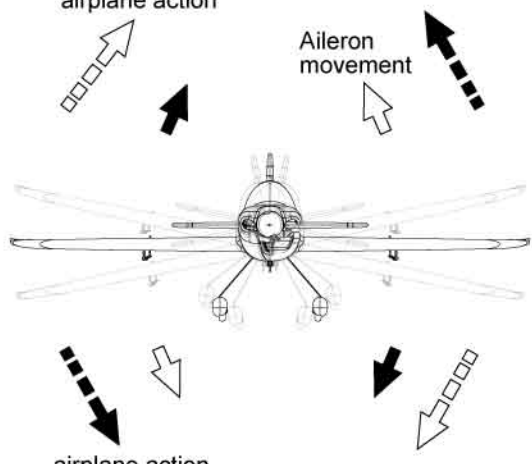
MODE 1	MODE 2	MOVEMENT
<p><b>THROTTLE</b></p> 		
<p><b>RUDDER</b></p> 		
<p><b>ELEVATOR</b></p> 		
<p><b>AILERONS</b></p> 		



# CG And Receiver Assembling

The ideal C.G. position is 40~45mm behind the leading edge measured at where the wing meets the fuselage. In order to obtain the C.G. specified, add weight to the fuselage or move the battery position. Check the C.G. before flying.

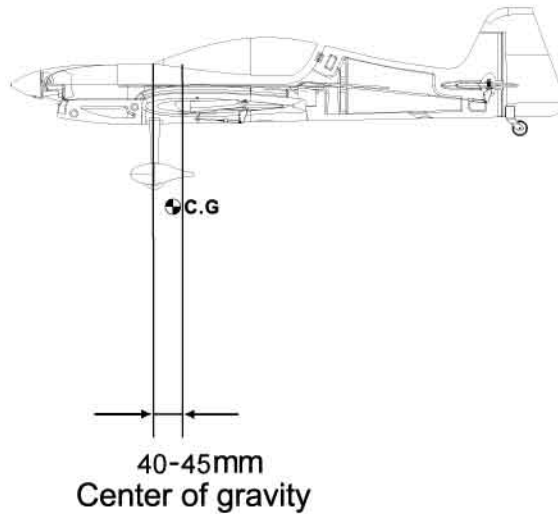
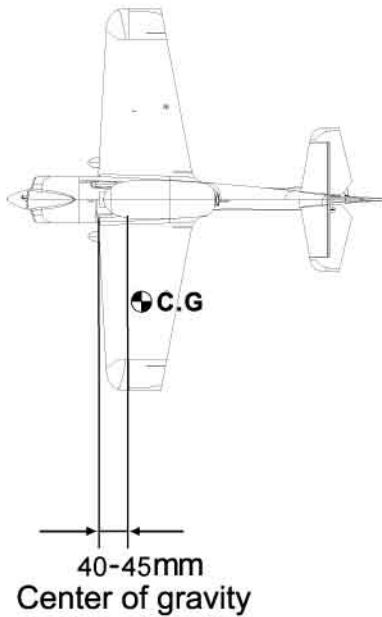

## Suggest Control Throw Setting

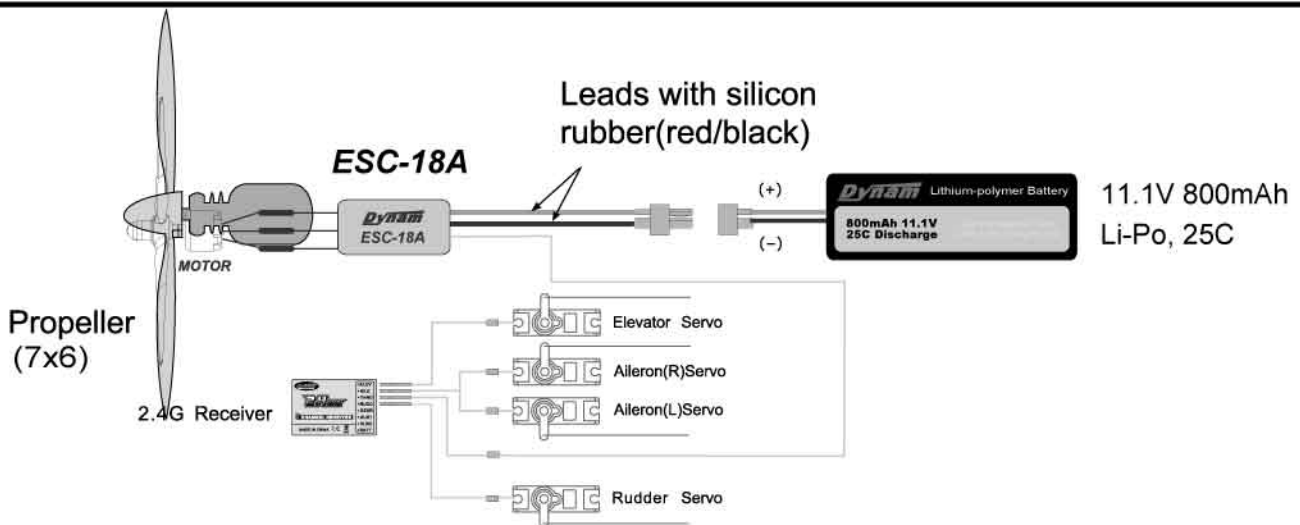
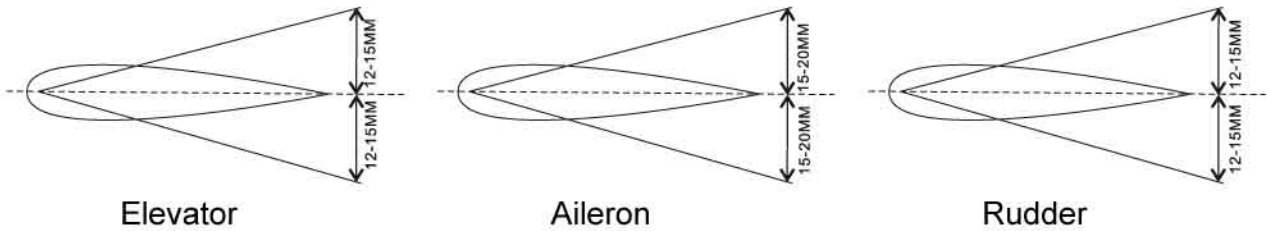



# Manual of Brushless Motor Speed Controller

## Specifications:

Pentium Series											
Class	Model	Cont. Current	Burst Current (>10s)	BEC Mode (Note1)	BEC Output	Battery Cell		User Programmable	Balance Discharge Protection	Weight	Size
						Li-ion Li-poly	NiMH NiCd				L*W*H
12A	Esc-12	12A	15A	Switch	5V/3A	2-4	5-12	Available	N/A	19g	45*24*9
18A	Esc-18	18A	22A	Switch	5V/3A	2-4	5-12	Available	N/A	19g	45*24*11
25A	Esc-25	25A	35A	Switch	5V/3A	2-4	5-12	Available	N/A	22g	45*24*11
30A	Esc-30	30A	40A	Switch	5V/3A	2-4	5-12	Available	N/A	25g	45*24*11
40A	Esc-40	40A	55A	Switch	5V/3A	2-6	5-18	Available	N/A	35g	55*28*12
50A	Esc-50	50A	80A	Switch	5V/3A	2-6	5-18	Available	N/A	60g	70*31*14
60A	Esc-60	60A	80A	Switch	5V/3A	2-6	5-18	Available	N/A	60g	70*31*14
70A	Esc-70	70A	100A	Switch	5V/3A	2-6	5-18	Available	N/A	62g	70*31*14
80A	Esc-80	80A	100A	Switch	5V/3A	2-6	5-18	Available	N/A	62g	70*31*14

## Wiring Diagram:

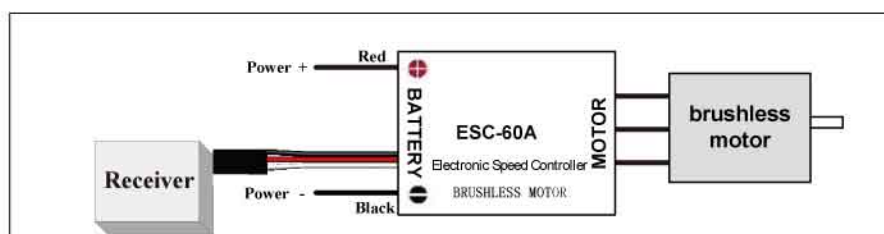

## Programmable Items:

- Brake Setting:** Enabled / Disabled, default is Disabled
- Battery Type:** Li-xx(Li-ion or Li-poly) / Ni-xx(NiMH or NiCd), default is Li-xx.
- Low Voltage Protection Mode(Cut-Off Mode):** Soft Cut-Off (Gradually reduce the output power) or Cut-Off (Immediately stop the output power). Default is Soft Cut-Off.
- Low Voltage Protection Threshold(Cut-Off Threshold):** Low / Medium / High, default is Medium.
  - ◆ **When NOT using balance discharge monitoring and protection function** (i.e. Not plugging the balance charge connector into the BDMP socket on the Guard series ESC, the ESC only monitors the voltage of the whole battery pack )
    - For lithium batteries, the number of battery cells is calculated automatically. Low / medium / high cutoff voltage for each cell is: 2.6V/2.85V/3.1V. For example: For a 3 cells lithium pack, when "Medium" cutoff threshold is set, the cut-off voltage will be: 2.85\*3=8.55V.
    - For nickel batteries, low / medium / high cutoff voltages are 0%/45%/60% of the startup voltage (i.e. the initial voltage of battery pack), and 0% means the low voltage cut-off function is disabled. For example: For a 10 cells NiMH battery, fully charged voltage is 1.44\*10=14.4V, when "Medium" cut-off threshold is set, the cut-off voltage will be: 14.4\*45%=6.5V.
  - ◆ **When using balance discharge monitoring and protection function** (i.e. Plugging the balance charge connector on battery pack into the BDMP socket on the Guard series ESC, the ESC monitors not only the voltage of the whole battery pack but also the voltage of each cell). For lithium battery, low / medium / high cut off voltage for each cell is: 2.6V/2.85V/3.1V. When the voltage of any cell in battery pack is lower than the cut-off threshold, the protection function is activated.
- Startup Mode:** Normal /Soft /Super-Soft, default is Normal.  
Normal is preferred for fixed-wing aircraft. Soft or Super-soft are preferred for helicopters. The initial acceleration of the Soft and Super-Soft modes are slower in comparison, usually taking 1 second for Soft startup or 2 seconds for Super-Soft startup from initial throttle advance to full throttle. If the throttle is closed (throttle stick moved to bottom) and opened again (throttle stick moved to top) within 3 seconds of the initial startup, the restart-up will be temporarily changed to normal mode to get rid of the chances of a crash caused by slow throttle response. This special design is very suitable for aerobatic flight when quick throttle response is needed.
- Timing:** Low / Medium / High, default is Low. *Note2*  
Usually, low timing value can be used for most motors. We recommend the **Low** timing value for 2 poles motor and **Medium** timing value for motors with more than 6 poles to get a high efficiency. For higher speed, **High** timing value can be chosen.  
**Note2: After changing the timing setting, please test your RC model on ground prior to flight!**

## Begin To Use Your New ESC

Please start the ESC in the following sequences:

- Move the throttle stick to the bottom position and then switch on the transmitter.
- Connect the battery pack to the ESC, the ESC begins the self-test process, a special tone "♪ 123" is emitted, which means the voltage of the battery pack is in normal range, and then N "beep" tones will be emitted, means the number of lithium battery cells. Finally a long "beep-----" tone will be emitted, which means self-test is OK, the aircraft/helicopter is ready to go flying.
  - ◆ If nothing is happened, please check the battery pack and all the connections;

# Manual of Brushless Motor Speed Controller

- ◆ If a special tone “♪ 567î2” is emitted after 2 beep tones (“beep-beep-”), means the ESC has entered the program mode, it is because the throttle channel of your transmitter is reversed, please set it correctly;
  - ◆ If the very rapid “beep-beep-, beep-beep-” tones is emitted, means the input voltage is too low or too high, please check your battery’s voltage.
3. **“VERY IMPORTANT !”** Because different transmitter has different throttle range, we strongly suggest you using the “Throttle Range Setting Function” to calibrate throttle range. Please read the instruction on page 4-----“Throttle Range Setting”.

## Alert Tone

1. Input voltage is abnormal: The ESC begins to check the voltage when the battery pack is connected, if the voltage is not in the acceptable range, such an alert tone will be emitted: “beep-beep-, beep-beep-,beep-beep-” (Every “beep-beep-” has a time interval of about 1 second.)
2. Throttle signal is abnormal: When the ESC can’t detect the normal throttle signal, such an alert tone will be emitted: “beep-, beep-, beep-”. (Every “beep-” has a time interval of about 2 seconds)
3. Throttle stick is not in the bottom position: When the throttle stick is not in bottom (lowest) position, a very rapid alert tone will be emitted: “beep-, beep-, beep-”. (Every “beep-” has a time interval of about 0.25 second.)

## Protection Function

1. Abnormal start up protection: If the motor fails to start within 2 seconds of throttle application, the ESC will cut-off the output power. In this case, the throttle stick **MUST** be moved to the bottom again to restart the motor. (Such a situation happens in the following cases: The connection between ESC and motor is not reliable, the propeller or the motor is blocked, the gearbox is damaged, etc.)
2. Over-heat protection: When the temperature of the ESC is over 110 Celsius degrees, the ESC will reduce the output power.
3. Throttle signal loss protection: The ESC will reduce the output power if throttle signal is lost for 1 second, further loss for 2 seconds will cause its output to be cut-off completely.

## Program Example

Setting “Start Mode” to “Super-Soft”, i.e. value #3 in the programmable item #5

<p><b>1. Enter Program Mode</b> Switch on transmitter, move throttle stick to top position, connect battery pack to ESC, wait for 2 seconds, “beep-beep” tone should be emitted. Then wait for another 5 seconds, special tone like ‘♪ 567î2’ should be emitted, which means program mode is entered.</p>
<p><b>2. Select Programmable Items</b> Now you’ll hear 8 tones in a loop. When a long “beep-----” tone is emitted, move throttle stick to bottom to enter the “Start Mode”</p>
<p><b>3. Set Item Value (Programmable Value)</b> “Beep-”, wait for 3 seconds; “Beep-beep-”, wait for another 3 seconds; then you’ll hear “beep-beep-beep”, move throttle stick to top position, then a special tone “♪ î5î5” is emitted, now you have set the “Start Mode” item to the value of “Super-Soft”</p>
<p><b>4. Exit Program Mode</b> After the special tone “♪ î5î5”, move throttle stick to bottom within 2 seconds.</p>

## Trouble Shooting

Trouble	Possible Reason	Action
After power on, motor does not work, no sound is emitted	The connection between battery pack and ESC is not correct	Check the power connection. Replace the connector.
After power on, motor does not work, such an alert tone is emitted: “beep-beep-, beep-beep-,beep-beep-” (Every “beep-beep-” has a time interval of about 1 second)	Input voltage is abnormal, too high or too low. The balance charge connector is not located properly in BDMP adapter.	Check the voltage of battery pack  Check the connection of the balance charge connector and the BDMP adapter.
After power on, motor does not work, such an alert tone is emitted: “beep-, beep-, beep- ”(Every “beep-” has a time interval of about 2 seconds)	Throttle signal is irregular	Check the receiver and transmitter Check the cable of throttle channel
After power on, motor does not work, such an alert tone is emitted: “beep-, beep-, beep-” (Every “beep-” has a time interval of about 0.25 second)	The throttle stick is not in the bottom (lowest) position	Move the throttle stick to bottom position
After power on, motor does not work, a special tone “♪ 567î2” is emitted after 2 beep tone (beep-beep-)	Direction of the throttle channel is reversed, so the ESC has entered the program mode	Set the direction of throttle channel correctly
The motor runs in the opposite direction	The connection between ESC and the motor need to be changed.	Swap any two wire connections between ESC and motor
The motor stop running while in working state	Throttle signal is lost	Check the receiver and transmitter Check the cable of throttle channel
	ESC has entered Low Voltage Protection mode	Land RC model as soon as possible, and then replace the battery pack
	Some connections are not reliable	Check all the connections: battery pack connection, throttle signal cable, motor connections, etc.
Random stop or restart or irregular working state	There is strong electro-magnetic interference in flying field.	Reset the ESC to resume normal operation. If the function could not resume, you might need to move to another area to fly.

# Manual of Brushless Motor Speed Controller

## Normal startup procedure:

Move throttle stick to bottom and then switch on transmitter.	Connect battery pack to ESC, special tone like "♪123" means power supply is OK	Several "beep-" tones should be emitted, presenting the number of lithium battery cells	When self-test is finished, a long "beep-----" tone should be emitted	Move throttle stick upwards to go flying
---	--	---	---	--

## Throttle range setting: (Throttle range should be reset whenever a new transmitter is being used)

Switch on transmitter, move throttle stick to top	Connect battery pack to ESC, and wait for about 2 seconds	"Beep-Beep-" tone should be emitted, means throttle range highest point has been correctly confirmed	Move throttle stick to the bottom, several "beep-" tones should be emitted, presenting the number of battery cells	A long "Beep-" tone should be emitted, means throttle range lowest point has been correctly confirmed
---	---	--	--	---

## Program the ESC with your transmitter (4 Steps):

1. Enter program mode
2. Select programmable items
3. Set item's value (Programmable value)
4. Exit program mode

### 1. Enter program mode

- 1) Switch on transmitter, move throttle stick to top, connect the battery pack to ESC
- 2) Wait for 2 seconds, the motor should emit special tone like "beep-beep-"
- 3) Wait for another 5 seconds, special tone like "♪567i2" should be emitted, which means program mode is entered



### 2. Select programmable items:

After entering program mode, you will hear 8 tones in a loop with the following sequence. If you move the throttle stick to bottom within 3 seconds after one kind of tones, this item will be selected.

- |                           |                    |                  |
|---------------------------|--------------------|------------------|
| 1. "beep"                 | brake              | (1 short tone)   |
| 2. "beep-beep-"           | battery type       | (2 short tone)   |
| 3. "beep-beep-beep-"      | cutoff mode        | (3 short tone)   |
| 4. "beep-beep-beep-beep-" | cutoff threshold   | (4 short tone)   |
| 5. "beep-----"            | startup mode       | (1 long tone)    |
| 6. "beep-----beep-"       | timing             | (1 long 1 short) |
| 7. "beep-----beep-beep-"  | set all to default | (1 long 2 short) |
| 8. "beep-----beep-----"   | exit               | (2 long tone)    |

**Note:** 1 long "beep-----" = 5 short "beep-"



### 3. Set item value (Programmable value):

You will hear several tones in loop. Set the value matching to a tone by moving throttle stick to top when you hear the tone, then a special tone "♪i5i5" emits, means the value is set and saved. (Keeping the throttle stick at top, you will go back to step 2 and you can select other items; Moving the stick to bottom within 2 seconds will exit program mode directly)

Items	Tones		
	"beep-" 1 short tone	"beep-beep-" 2 short tones	"beep-beep-beep-" 3 short tones
Brake	Off	On	
Battery type	Li-ion / Li-poly	NiMH / NiCd	
Cutoff mode	Soft-Cut	Cut-Off	
Cutoff threshold	Low	Medium	High
Start mode	Normal	Soft	Super soft
Timing	Low	Medium	High



### 4. Exit program mode

There are 2 ways to exit program mode:

1. In step 3, after special tone "♪i5i5", please move throttle stick to the bottom position within 2 seconds.
2. In step 2, after tone "beep-----beep-----"(ie. The item #8), move throttle stick to bottom within 3 seconds.



# How To Programming The ESC With The Dynam Radio

---

## How to enter the programming mode of the Dynam's brushless ESC with the Dynam 2.4Ghz radio system:

(Warning: Please disconnect the motor from the ESC before starting the following procedure)

- 1) Turn on the transmitter, then connect battery to the receiver, let the normal auto binding process completed. (Both LED lights on transmitter and receiver should flash rapidly at the same time for this process to succeed)
- 2) Disconnect the receive power; **do not turn off the transmitter.**
- 3) Move the throttle stick to the top position.
- 4) Toggle the safety switch (on the upper left hand corner of the transmitter). Then make sure the safety switch is at the off position (the tip of the switch is set toward the back of the transmitter)
- 5) Connect battery to the receiver; now you are ready to enter the programming mode (please see the ESC manual for programming instruction).
- 6) If unable to enter the programming mode, please repeat the above procedure again.

## Install the Transmitter Batteries

---

Install 8 new "AA" batteries in the included transmitter. Check the power level of the batteries and operation of the transmitter by switching the power switch on (upward). The status LEDs at the top of the transmitter will indicate the power level of the batteries . If at any time the status LEDs no longer show green, it will be necessary to replace the batteries with new ones.





# Decal

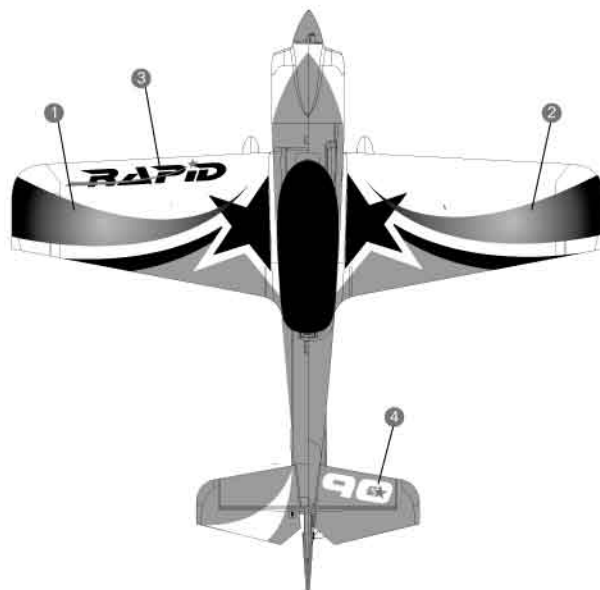
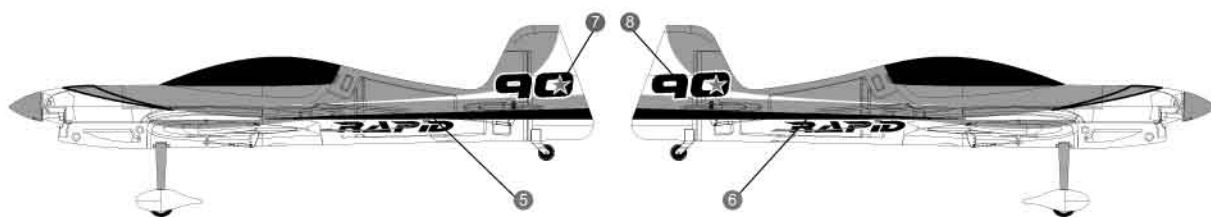
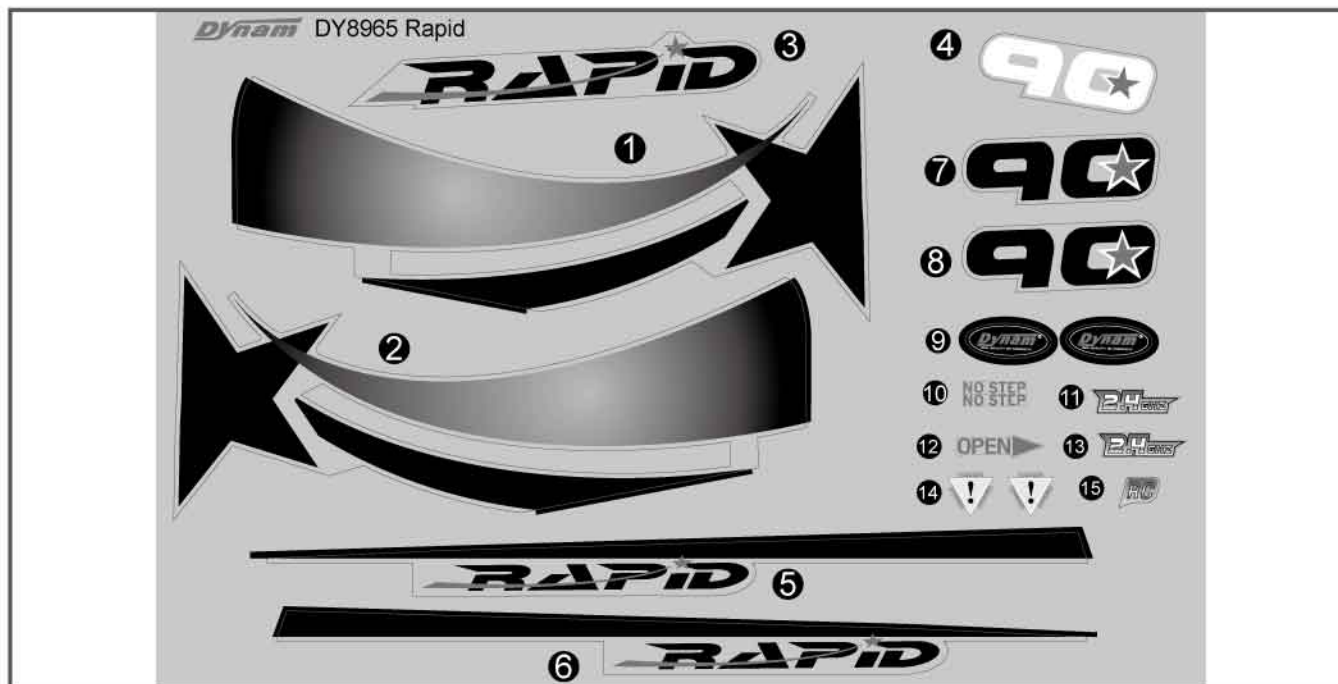

# Parts List



Rapid-01 Fuselage



Rapid-02 Wing



Rapid-03 Elevator

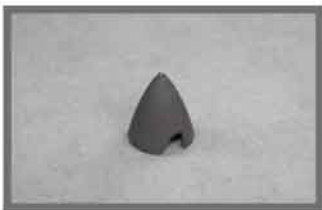

Rapid-04 Spinner

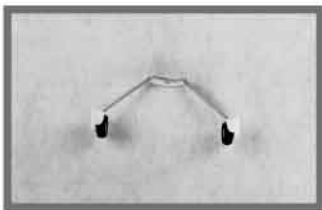

Rapid-05 Landing gear

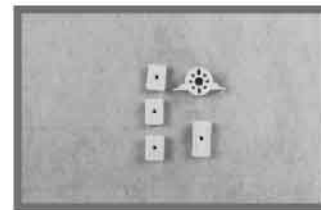

Rapid-06 Plastic Parts

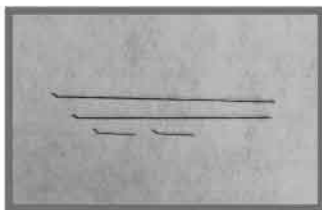

Rapid-07 Push rod

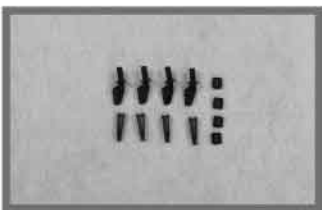

Rapid-08 Servo Horn



Rapid-09 Prop adaptor



Rapid-10 Decal

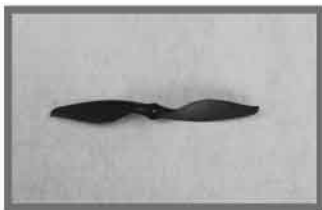

DYP-1021 7\*6 Propeller



DY-1100 3.7g Servo



DYT-2001 2.4G Transmitter

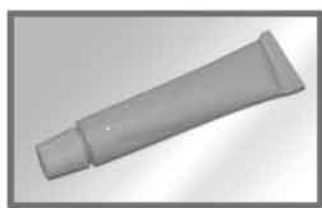

DY-3003 Glue



DY-6017 11.1V 800mAh 25C Battery



DYE-1001 18A ESC



DYR-2002 2.4G Receiver



DYC-1002 Balance charger



Brushless Motor BM2313 KV1500

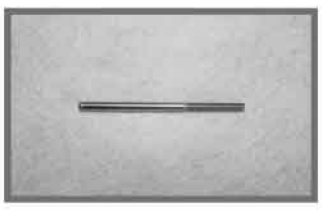

BM2313 KV1500-Shaft motor shaft



DYA-0001/ 2 / 3 / 4  
EU/US/KU/AU Adaptor



## SMART

### Specification:

Wingspan: ————— .1500mm (59.06in)  
 Overall Length: ————— 1300mm(51.2in)  
 Wing Loading: ————— 54.5g/dm<sup>2</sup>  
 Servo: ————— 17g x4pcs, 9gx1pcs  
 Battery: ————— 14.8V 2600mAh Li-Po, 25C  
 Speed Controller: ———— 40A Brushless  
 Motor Size: ————— BM3720A-KV600 Brushless Outrunner  
 Flying Weight: ————— 1800g(63.6oz)



## BEAVER DHC-2

### Specification:

Wingspan: ————— .1500mm (59.06in)  
 Overall Length: ————— 958mm(37.7in)  
 Wing Loading: ————— 58g/dm<sup>2</sup>  
 Servo: ————— 9g x5pcs  
 Battery: ————— 14.8V 2200mAh Li-Po, 25C  
 Speed Controller: ———— 50A Brushless  
 Motor Size: ————— BM3720A-KV650 Brushless Outrunner  
 Flying Weight: ————— 1400-1750g(49.4-61.8oz)



## P-51D

### Specification:

Wingspan: ————— .762 mm(30in)  
 Overall Length: ————— 665 mm(26.2in)  
 Wing Loading: ————— 27g/dm<sup>2</sup>  
 Servo: ————— 3.7g x4pcs  
 Battery: ————— 7.4V 850mAh Li-Po, 15C  
 Speed Controller: ———— 18A Brushless  
 Motor Size: ————— BM2804 KV1900 Brushless Outrunner  
 Flying Weight: ————— 300g(10.6oz)



迪乐美



English | 中文

Search by Keyword



Home

Products

Online Mall

Service

Join

News

About Us

Contact Us



## Categories

### ► Airplanes

- Trainer
- Warbirds
- Aerobatic
- Scales
- Ducted Fan
- Glider
- bi-planes

### ► Helicopters

### ► Rc Electronics

### ► Power Systems

### ► Brushless Motors

### ► Accessories

## New Products

### New airplane



Smart



Albatross Dv.a



Hawker Tempest



F6F Hellcat



Tiger Moth



P-47D THUNDERBOLT

- TEL:+86-769-87566018
- E-mail:sales@dynam-rc.cn
- FAX:+86-769-87555185
- Http:www.dynam-rc.cn
- Add:No.C-02 Nanshan Industry Town Yantian Fenggang  
City Dongguan Guangdong Province